

# Ultrasound Dilution Technology

## Hemodialysis Monitor Theory of Operation

### Transonic® HD-Series Monitors Use Ultrasound Indicator Dilution Technology to Measure:

- Delivered Blood Flow (flow in the dialysis tubing, pump flow): Ultrasound sensors clipped onto hemodialysis tubing blood lines transmit minute levels of ultrasound through the tubing wall into the blood stream. Sensitive electronics derive flow via transit-time ultrasound principles.
- Access Recirculation: Using indicator dilution principles, the same sensors sense the direct reflux of saline from the venous line back into the arterial line after a saline indicator change in the venous blood line.
- Access Flow: After reversing the blood lines, the sensors measure Access Flow by the patented Krivitski Method®.
- Cardiac Output: With blood lines in their normal position, the Transonic monitor analyzes cardio-pulmonary recirculation (CPR) to measure cardiac output.

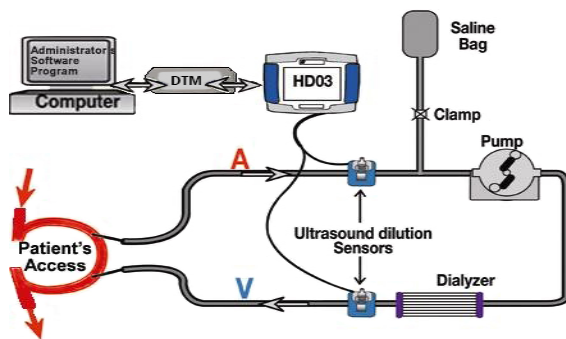

Fig. 1: Transit-time flow/dilution sensing during hemodialysis.

### System Components

- Transonic® Hemodialysis Monitor
- Arterial & Venous Flow/Dilutions Sensors
- Laptop computer for automated calculations
- Isotonic saline (0.9% NaCl) released from the patient's saline bag or by direct injection into the blood line.

Protected under USA patents # 5,453,576; 5,595,182; 5,685,989.  
International patent #EP 0 781 161 B1

UltrasoundDilutionPrinciple(DL-22-tnRevB2013)USltr

### Differential Transit-Time Ultrasound Delivered Blood Flow

The clip-on sensor transmits a beam of ultrasound through the blood line. Two transducers pass ultrasonic signals back and forth, alternately intersecting the flowing blood in upstream and downstream directions. The Hemodialysis Monitor derives an accurate measure of the changes in the time it takes for the wave of ultrasound to travel from one transducer to the other ("transit time") resulting from the flow of blood in the vessel. The difference between the upstream and downstream transit times is a measure of volume flow.

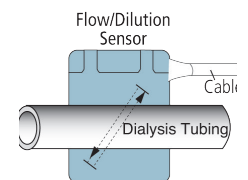

Fig. 2: Clip-on Flow/Dilution Sensor

During hemodialysis two matched flow/dilution sensors are clipped onto the arterial and venous dialysis lines (Fig. 1). The monitor continuously displays delivered blood flow. Comparison of this reading with the pump flow setting (i.e., the flow the pump tries to deliver) provides an opportunity to identify and correct dialysis delivery problems.

### Ultrasound Indicator Dilution Patient Blood Flows & Recirculation

The velocity of ultrasound in blood (1560-1590 m/sec) is determined primarily by its blood protein concentration. The Transonic® Hemodialysis Monitor and Flow/dilution Sensors measure ultrasound velocity. A bolus of isotonic saline (ultrasound velocity: 1533 m/sec) introduced into the blood stream dilutes the blood and reduces the ultrasound velocity. The sensor records this saline bolus as a conventional indicator dilution curve.

When a bolus of saline indicator is introduced into the blood line, the arterial and venous sensors each register an indicator dilution curve. The following measurements can be selected:

# Ultrasound Dilution Technology Cont.

## Access Recirculation

The Hemodialysis Monitor identifies the direct reflux of the venous saline indicator bolus into the arterial line (Figs. 3,4). The ratio of indicator concentrations equals access recirculation. High timing resolution enables identification of zero access recirculation.

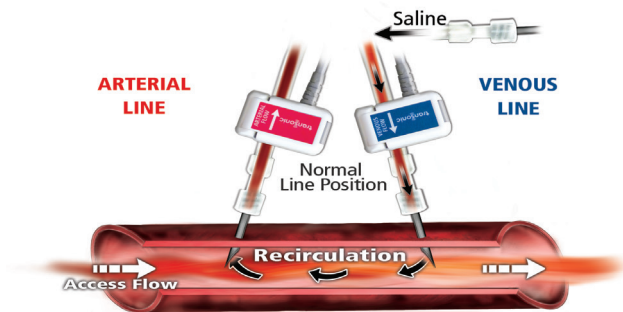

Fig. 3: Recirculation Measurement. Saline is introduced into the venous sensor with the dialysis lines in normal position. The arterial sensor measures the diluted concentration of blood from which recirculation is calculated.

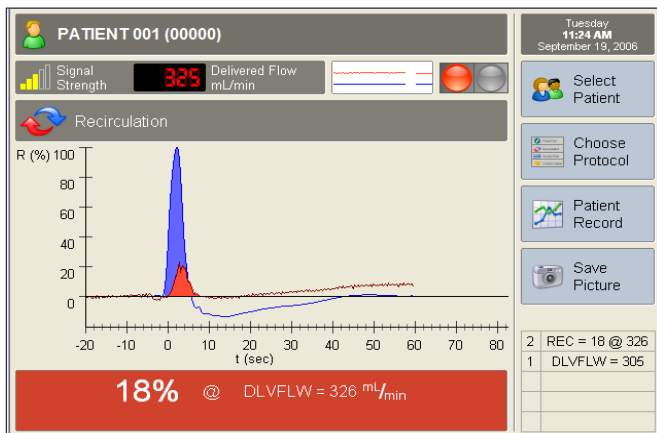

Fig. 4: Typical indicator concentration curves showing 18% access recirculation.

## Vascular Access Flow

The Krivitski Method® to measure vascular access flow is a pioneering Transonic® contribution to vascular access management (Fig. 5). A saline indicator is introduced via the upstream (venous) access needle into the access flow stream. The downstream (arterial) access needle samples the blood concentration diluted by the indicator (Fig. 6) from which vascular access flow is calculated.

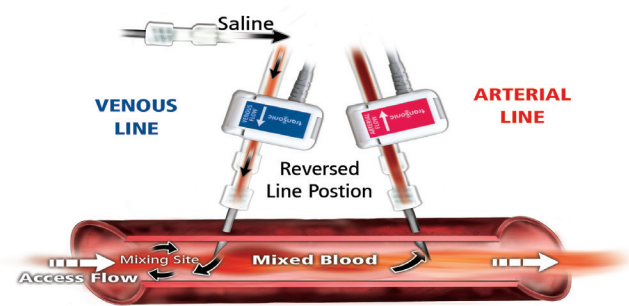

Fig. 5: Krivitski Method® Access Flow Measurement. When dialysis lines are reversed to induce recirculation, vascular access flow ( $Q_a$ ) can be calculated.

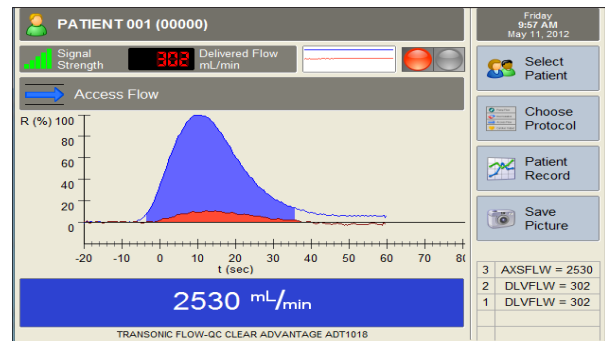

Fig. 6: Typical induced recirculation curves for the Krivitski Method® for calculating  $Q_a$ .

## Cardiac Output

When blood lines are in their normal position and there is no access recirculation, the complete bolus of saline indicator travels into the heart where it is mixed (diluted) into the full output of the heart. Part of this diluted indicator then reappears at the Transonic® arterial sensor as cardiopulmonary recirculation which represents a measure of cardiac output (Fig. 7). Cardiac output and Cardiac Index are calculated using conventional Stewart-Hamilton analysis.

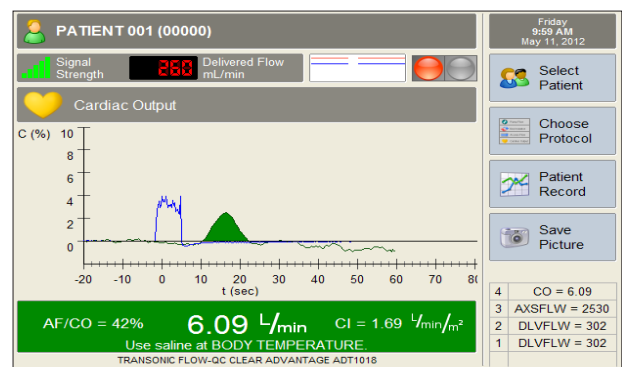

Fig. 7: Typical cardiac output indicator concentration curves.